



### ■ Features

- Constant Current mode output
- Metal housing with Class I design
- Built-in active PFC function
- IP67 / IP65 design for indoor or outdoor installations
- Function options: output adjustable via potentiometer; 3 in 1 dimming; Timer dimming
- Typical lifetime > 62000 hours
- 7 years warranty

### ■ Applications

- LED street lighting
- LED fishing lamp
- LED harbor lighting
- LED building architectural lighting
- LED greenhouse lighting
- LED bay lighting

### ■ Description

HLG-60H-C series is a 70W AC/DC LED driver featuring the constant current mode and high voltage output. HLG-60H-C operates from 90~305VAC and offers models with different rated current ranging between 350mA and 700mA. Thanks to the high efficiency up to 91%, with the fanless design, the entire series is able to operate for -40°C ~ +80°C case temperature under free air convection. The design of metal housing and IP67/IP65 ingress protection level allows this series to fit both indoor and outdoor applications. HLG-60H-C is equipped with various function options, such as dimming methodologies, so as to provide the optimal design flexibility for LED lighting system.

### ■ Model Encoding

**HLG - 60 H - C700 A**

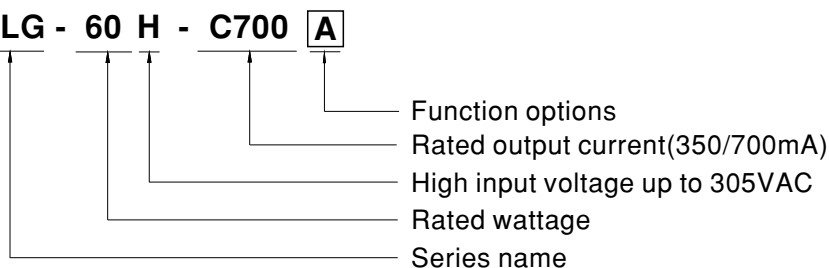

Type	IP Level	Function	Note
A	IP65	Io adjustable through built-in potentiometer.	In Stock
B	IP67	3 in 1 dimming function (1~10Vdc, 10V PWM signal and resistance)	In Stock
D	IP67	Timer dimming function, contact MEAN WELL for details(safety pending).	By request



**SPECIFICATION**

MODEL		HLG-60H-C350 <input type="checkbox"/>	HLG-60H-C700 <input type="checkbox"/>
OUTPUT	RATED CURRENT	350mA	700mA
	RATED POWER	70W	70W
	CONSTANT CURRENT REGION <small>Note.2</small>	100 ~ 200V	50 ~ 100V
	CURRENT ADJ. RANGE	Adjustable for A-Type only (via built-in potentiometer)	
		210 ~ 350mA	420 ~ 700mA
	CURRENT RIPPLE	5.0% max. @rated current	
	CURRENT TOLERANCE	±5%	
SET UP TIME <small>Note.4</small>	750ms/115VAC, 500ms/230VAC		
INPUT	VOLTAGE RANGE <small>Note.3</small>	90 ~ 305VAC 127 ~ 431VDC (Please refer to "STATIC CHARACTERISTIC" section)	
	FREQUENCY RANGE	47 ~ 63Hz	
	POWER FACTOR (Typ.)	PF ≥ 0.98/115VAC, PF ≥ 0.96/230VAC, PF ≥ 0.94/277VAC @full load (Please refer to "POWER FACTOR (PF) CHARACTERISTIC" section)	
	TOTAL HARMONIC DISTORTION	THD < 20% (@ load ≥ 60% /115VAC, 230VAC; @ load ≥ 75%/277VAC) (Please refer to "TOTAL HARMONIC DISTORTION (THD)" section)	
	EFFICIENCY (Typ.)	91%	90.5%
	AC CURRENT (Typ.)	0.69A / 115VAC	0.35A / 230VAC 0.29A / 277VAC
	INRUSH CURRENT(Typ.)	COLD START 60A( <small>t</small> width=275µs measured at 50% Ipeak) at 230VAC; Per NEMA 410	
	MAX. No. of PSUs on 16A CIRCUIT BREAKER	8 units (circuit breaker of type B) / 13 units (circuit breaker of type C) at 230VAC	
	LEAKAGE CURRENT	<0.75mA / 277VAC	
PROTECTION	SHORT CIRCUIT	Hiccup mode, recovers automatically after fault condition is removed	
	OVER VOLTAGE	230 ~ 250V	120 ~ 140V
	OVER TEMPERATURE	Shut down o/p voltage, re-power on to recover	
ENVIRONMENT	WORKING TEMP.	Tcase=-40 ~ +80°C (Please refer to "OUTPUT LOAD vs TEMPERATURE" section)	
	MAX. CASE TEMP.	Tcase=+80°C	
	WORKING HUMIDITY	10 ~ 95% RH non-condensing	
	STORAGE TEMP., HUMIDITY	-40 ~ +80°C, 10 ~ 95% RH	
	TEMP. COEFFICIENT	±0.03%/°C (0 ~ 50°C)	
	VIBRATION	10 ~ 500Hz, 5G 12min./1cycle, period for 72min. each along X, Y, Z axes	
SAFETY & EMC	SAFETY STANDARDS <small>Note.6</small>	UL8750, CSA C22.2 No. 250.0-08, TUV EN61347-1, EN61347-2-13 independent, IP65 or IP67, J61347-1, J61347-2-13 approved	
	WITHSTAND VOLTAGE	I/P-O/P:3.75KVAC I/P-FG:2KVAC O/P-FG:1.5KVAC	
	ISOLATION RESISTANCE	I/P-O/P, I/P-FG, O/P-FG:100M Ohms / 500VDC / 25°C / 70% RH	
	EMC EMISSION <small>Note.6</small>	Compliance to EN55015, EN61000-3-2 Class C (@ load ≥ 60%) ; EN61000-3-3	
	EMC IMMUNITY	Compliance to EN61000-4-2,3,4,5,6,8,11, EN61547, heavy industry level (surge immunity Line-Earth 4KV, Line-Line 2KV)	
OTHERS	MTBF	878.1K hrs min. Telcordia SR-332 (Bellcore) ; 338K hrs min. MIL-HDBK-217F (25°C)	
	DIMENSION	171*61.5*36.8 mm (L*W*H)	
	PACKING	0.73Kg; 20pcs/15.6Kg/0.9CUFT	
NOTE	<ol style="list-style-type: none"> <li>All parameters NOT specially mentioned are measured at 230VAC input, rated current and 25°C of ambient temperature.</li> <li>Please refer to "DRIVING METHODS OF LED MODULE".</li> <li>De-rating may be needed under low input voltages. Please refer to "STATIC CHARACTERISTIC" sections for details.</li> <li>Length of set up time is measured at first cold start. Turning ON/OFF the driver may lead to increase of the set up time.</li> <li>The driver is considered as a component that will be operated in combination with final equipment. Since EMC performance will be affected by the complete installation, the final equipment manufacturers must re-qualify EMC Directive on the complete installation again.</li> <li>The model certified for CCC(GB19510.14, GB19510.1, GB17743 and GB17625.1) is an optional model . Please contact MEAN WELL for details.</li> <li>To fulfill requirements of the latest ErP regulation for lighting fixtures, this LED driver can only be used behind a switch without permanently connected to the mains.</li> <li>This series meets the typical life expectancy of &gt;62,000 hours of operation when Tcase, particularly (Tc) point (or TMP, per DLC), is about 75°C or less.</li> <li>Please refer to the warranty statement on MEAN WELL's website at <a href="http://www.meanwell.com">http://www.meanwell.com</a></li> </ol>		

## ■ BLOCK DIAGRAM

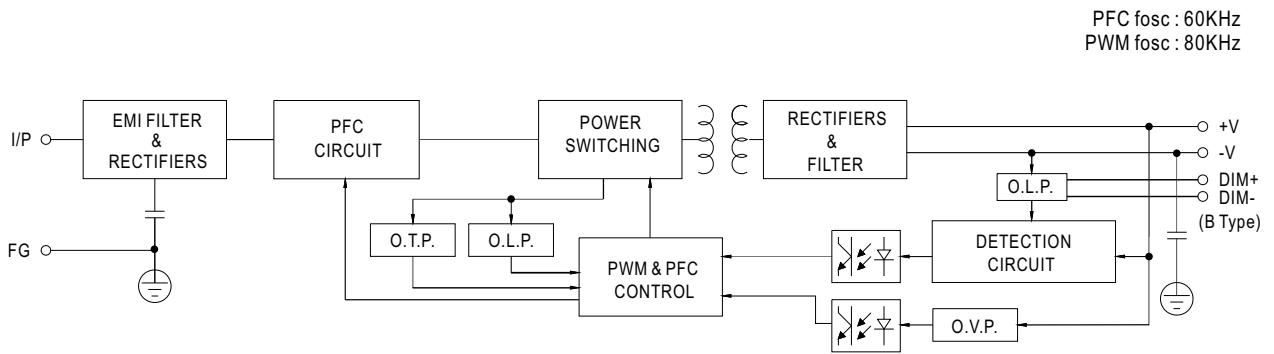

## ■ DRIVING METHODS OF LED MODULE

※ This series works in constant current mode to directly drive the LEDs.

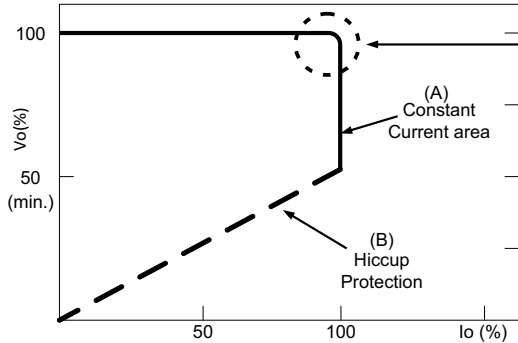

Typical output current normalized by rated current (%)

In the constant current region, the highest voltage at the output of the driver depends on the configuration of the end systems.

Should there be any compatibility issues, please contact MEAN WELL.

## DIMMING OPERATION



### ※ 3 in 1 dimming function (for B-Type)

- Output constant current level can be adjusted by applying one of the three methodologies between DIM+ and DIM-: 1 ~ 10VDC, or 10V PWM signal or resistance.
- Direct connecting to LEDs is suggested. It is not suitable to be used with additional drivers.
- Dimming source current from power supply: 100 $\mu$ A (typ.)

#### ◎ Applying additive 1 ~ 10VDC

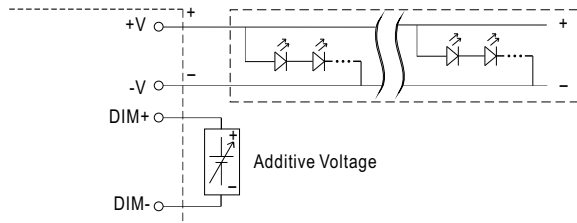

"DO NOT connect "DIM- to -V"

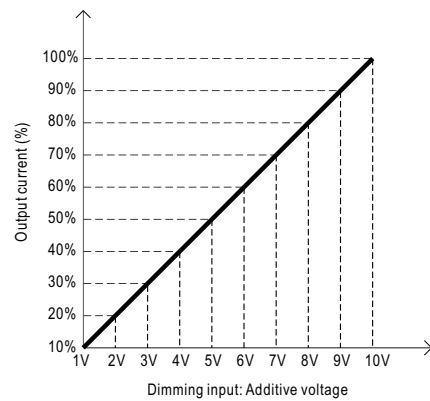

#### ◎ Applying additive 10V PWM signal (frequency range 100Hz ~ 3KHz):

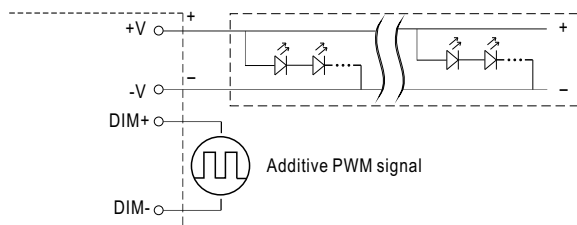

"DO NOT connect "DIM- to -V"

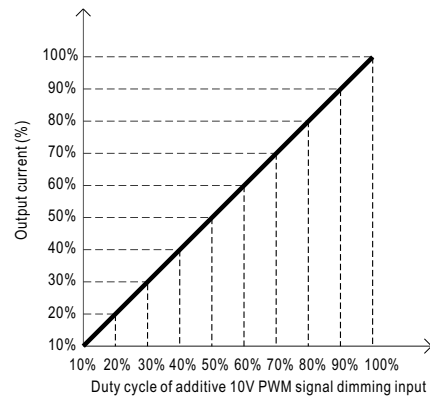

#### ◎ Applying additive resistance:

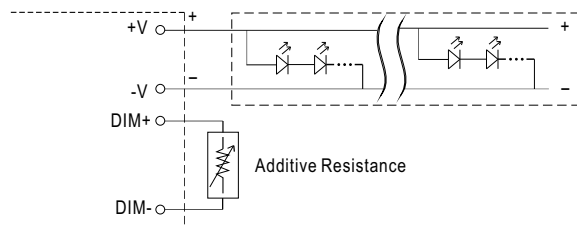

"DO NOT connect "DIM- to -V"

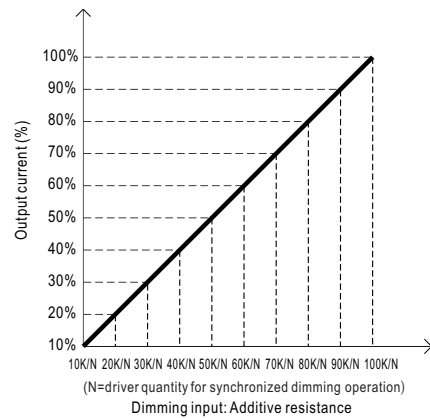

Note: In the case of turning the lighting fixture down to 0% brightness, please refer to the configuration as follow, or please contact MEAN WELL for other options.

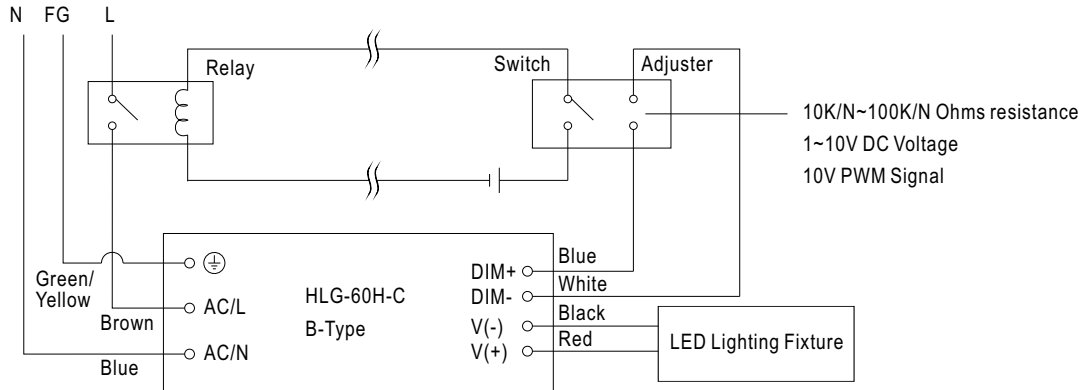

Using a switch and relay can turn ON/OFF the lighting fixture.

### OUTPUT LOAD vs TEMPERATURE

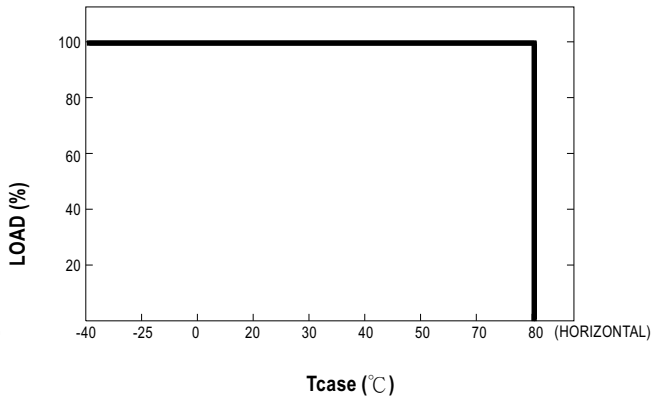
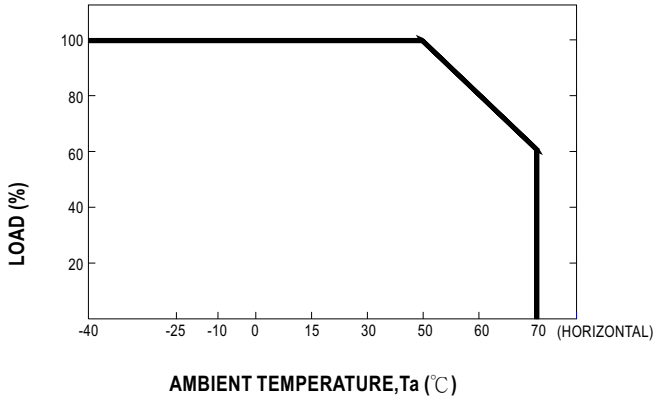

### STATIC CHARACTERISTIC

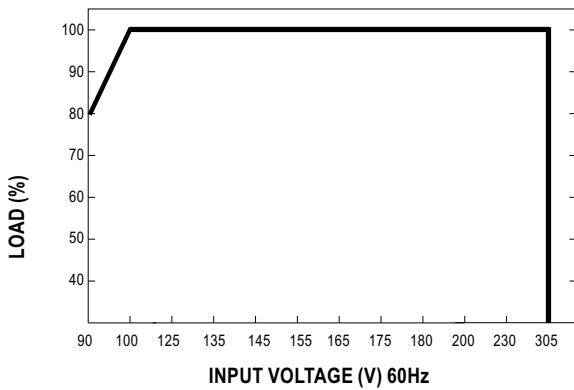

### POWER FACTOR (PF) CHARACTERISTIC

※ Tcase at 70°C

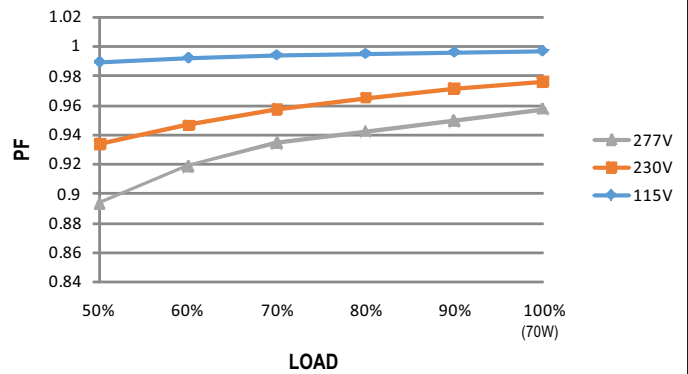

### TOTAL HARMONIC DISTORTION (THD)

※ 350mA Model, Tcase at 70°C

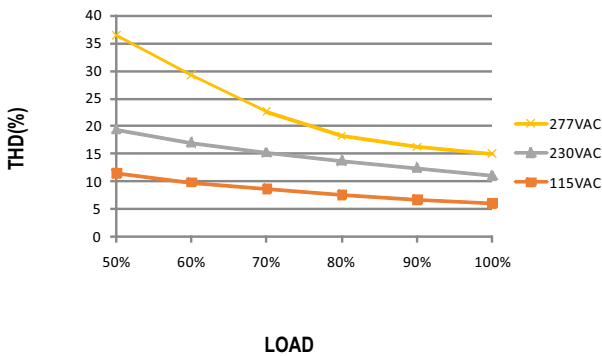

### EFFICIENCY vs LOAD

HLG-60H-C series possess superior working efficiency that up to 91% can be reached in field applications.

※ 350mA Model, Tcase at 70°C

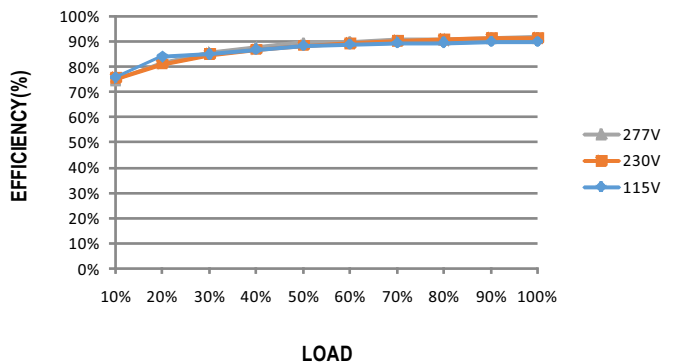



■ LIFE TIME

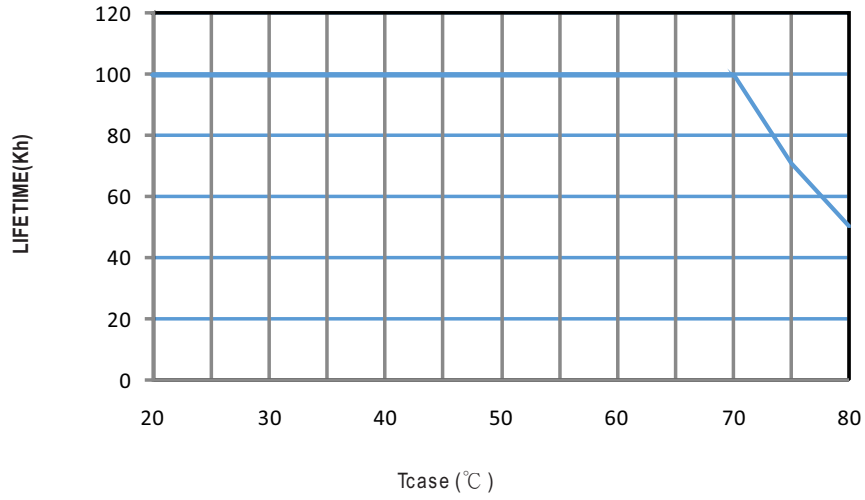

**MECHANICAL SPECIFICATION**

Case No.957 Unit:mm

※ **A-Type**

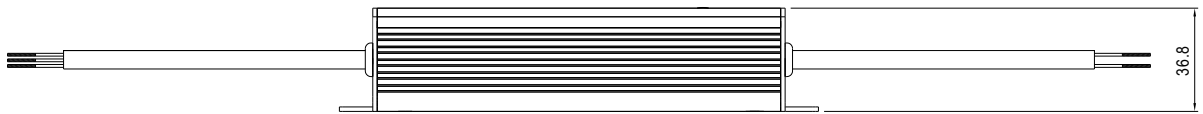
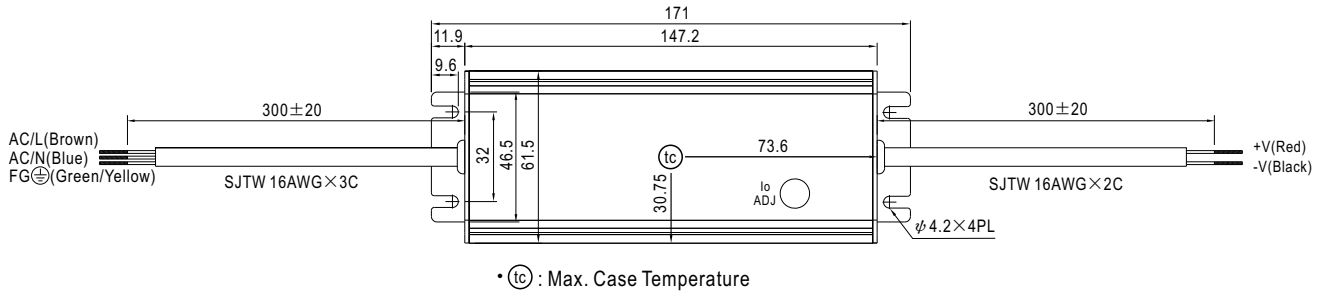

※ **B-Type**

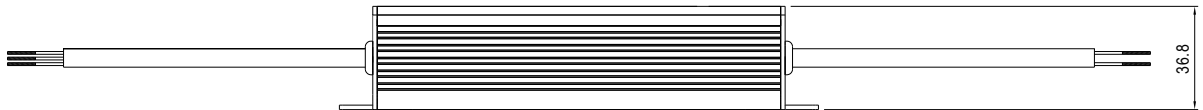
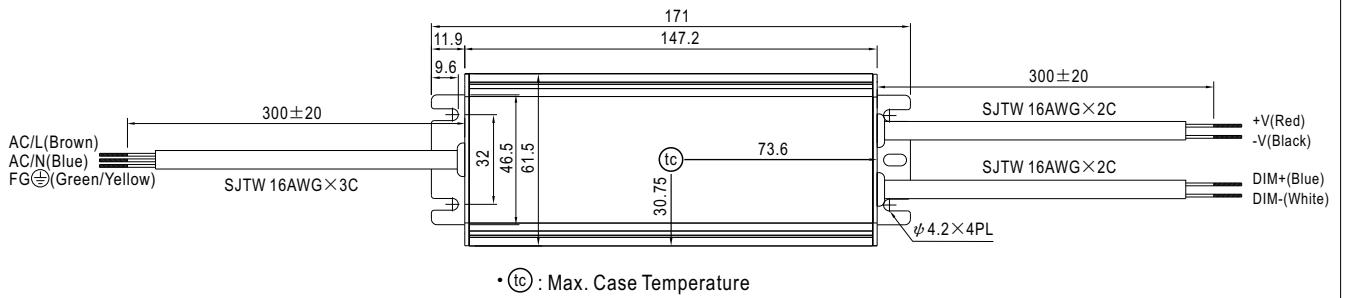

※ **D-Type**

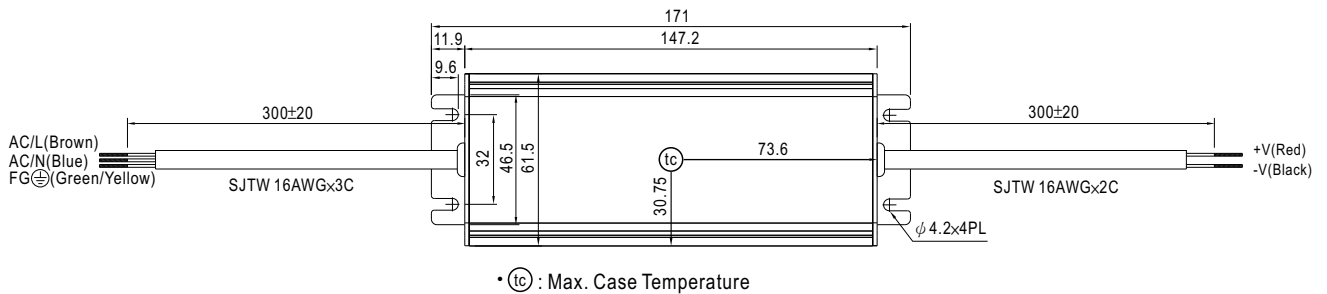



## ■ WATERPROOF CONNECTION

### ◎ Waterproof connector

Waterproof connector can be assembled on the output cable of HLG-60H-C to operate in dry/wet/damp or outdoor environment.

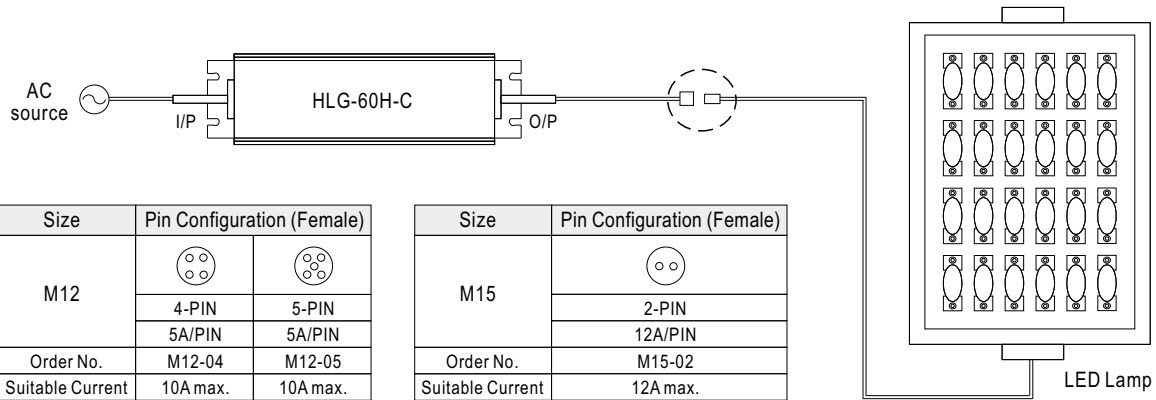

### ◎ Cable Joiner

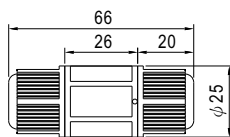

CJ04-1 suitable for 14AWG~16AWG  
CJ04-2 suitable for 18AWG~22AWG



Up to four wires can be connected through this cable joiner by soldering or clamping by tools.

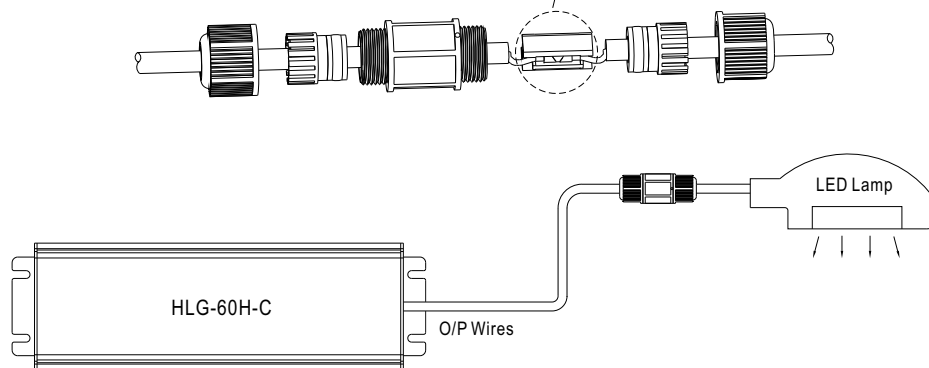

※CJ04 cable joiner can be purchased independently for user's own assembly.  
MEAN WELL order No. : CJ04-1, CJ04-2.

## ■ INSTALLATION MANUAL

Please refer to : <http://www.meanwell.com/webnet/search/InstallationSearch.html>