



■ Features

- Constant Current mode output with multiple levels selectable by dip switch
- Plastic housing with class II design
- Built-in active PFC function
- Standby power consumption <0.5W
- Functions: DALI interface(logarithm or linear dimming curve selectable), push dimming, synchronization up to 10units
- 3 years warranty

■ Applications

- LED indoor lighting
- LED office lighting
- LED architectural lighting
- LED panel lighting

■ Description

LCM-60DA series is a 60W AC/DC constant current mode output LED driver featuring the multiple levels selectable by dip switch and the DALI interface with the compliance to IEC62386-207. LCM-60DA operates from 180~295VAC and offers different current levels ranging between 500mA and 1400mA. Thanks to the high efficiency up to 92%, with the fanless design, the entire series is able to operate for -30°C~+90°C case temperature under free air convection. In addition, LCM-60DA is equipped with push dimming and synchronization so as to provide the optimal design flexibility for LED lighting system.

■ Model Encoding

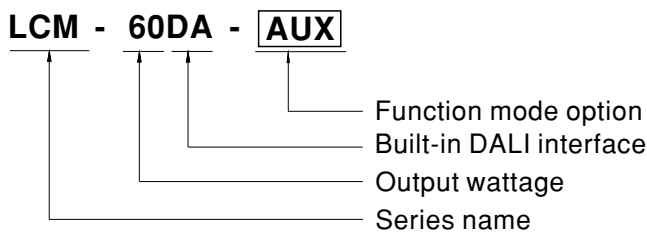

| Type  | Function  | Note       |
|-------|---|------------|
| Blank | DALI and push dimming ,with standby power consumption <0.5W                         | In Stock   |
| AUX   | DALI and push dimming, with standby power consumption <1.2W and Auxiliary DC output | By request |



## SPECIFICATION

|                                  |   |   |         |                |         |         |         |
|----------------------------------|---|---|---------|----------------|---------|---------|---------|
| MODEL                            |   | LCM-60DA-□  |         |                |         |         |         |
| OUTPUT                           | CURRENT LEVEL   | Current level selectable via DIP switch, please refer to "DIP SWITCH TABLE" section                               |         |                |         |         |         |
|                                  |   | 500mA   | 600mA   | 700mA(default) | 900mA   | 1050mA  | 1400mA  |
|                                  | RATED POWER   | 60.3W   |         |                |         |         |         |
|                                  | DC VOLTAGE RANGE  | 2 ~ 90V   | 2 ~ 90V | 2 ~ 86V        | 2 ~ 67V | 2 ~ 57V | 2 ~ 42V |
|                                  | OPEN CIRCUIT VOLTAGE (max.)   | 95V   |         |                | 73V     |         |         |
|                                  | CURRENT RIPPLE <small>Note.5</small>  | 5.0% max. @rated current  |         |                |         |         |         |
|                                  | CURRENT TOLERANCE   | ±5%   |         |                |         |         |         |
|                                  | AUXILIARY DC OUTPUT   | Nominal 12V(deviation 11.4~12.6V)@50mA for AUX-Type only  |         |                |         |         |         |
| SETUP TIME <small>Note.3</small> | 500ms / 230VAC  |   |         |                |         |         |         |
| INPUT                            | VOLTAGE RANGE <small>Note.2</small>   | 180 ~ 295VAC 254 ~ 417VDC<br>(Please refer to "STATIC CHARACTERISTIC" section)                                    |         |                |         |         |         |
|                                  | FREQUENCY RANGE   | 47 ~ 63Hz   |         |                |         |         |         |
|                                  | POWER FACTOR (Typ.)   | PF ≥ 0.975/230VAC, PF ≥ 0.96/277VAC@full load<br>(Please refer to "POWER FACTOR (PF) CHARACTERISTIC" section)     |         |                |         |         |         |
|                                  | TOTAL HARMONIC DISTORTION   | THD < 20% (@load ≥ 75%)<br>(Please refer to "TOTAL HARMONIC DISTORTION(THD)" section)                             |         |                |         |         |         |
|                                  | EFFICIENCY (Typ.) <small>Note.4</small>   | 92%   |         |                |         |         |         |
|                                  | AC CURRENT (Typ.)   | 0.32A/230VAC 0.27A/277VAC   |         |                |         |         |         |
|                                  | INRUSH CURRENT (Typ.)   | COLD START 20A(twidth=270μs measured at 50% I <sub>peak</sub> ) at 230VAC; Per NEMA 410                           |         |                |         |         |         |
|                                  | MAX. No. of PSUs on 16A CIRCUIT BREAKER   | 25 units (circuit breaker of type B) / 32 units (circuit breaker of type C) at 230VAC                             |         |                |         |         |         |
|                                  | LEAKAGE CURRENT   | <0.5mA / 240VAC   |         |                |         |         |         |
|                                  | STANDBY POWER CONSUMPTION <small>Note.6</small>   | <0.5W for Blank-Type, <1.2W for AUX-Type  |         |                |         |         |         |
| PROTECTION                       | SHORT CIRCUIT   | Constant current limiting, recovers automatically after fault condition is removed                                |         |                |         |         |         |
|                                  | OVER VOLTAGE  | 105 ~ 125V<br>Shutdown o/p voltage, re-power on to recover  |         |                |         |         |         |
|                                  | OVER TEMPERATURE  | Shutdown o/p voltage, re-power on to recover  |         |                |         |         |         |
| FUNCTION                         | DIMMING   | Please refer to "DIMMING OPERATION" section   |         |                |         |         |         |
|                                  | SYNCHRONIZATION   | Please refer to "SYNCHRONIZATION OPERATION" section   |         |                |         |         |         |
|                                  | TEMP. COMPENSATION  | By external NTC, please refer to "TEMPERATURE COMPENSATION OPERATION" section                                     |         |                |         |         |         |
| ENVIRONMENT                      | WORKING TEMP.   | T <sub>case</sub> = -30 ~ +90°C (Please refer to "OUTPUT LOAD vs TEMPERATURE" section)                            |         |                |         |         |         |
|                                  | MAX. CASE TEMP.   | T <sub>case</sub> = +90°C   |         |                |         |         |         |
|                                  | WORKING HUMIDITY  | 20 ~ 90% RH non-condensing  |         |                |         |         |         |
|                                  | STORAGE TEMP., HUMIDITY   | -40 ~ +80°C, 10 ~ 95% RH  |         |                |         |         |         |
|                                  | TEMP. COEFFICIENT   | ±0.03%/°C (0 ~ 50°C)  |         |                |         |         |         |
|                                  | VIBRATION   | 10 ~ 500Hz, 2G 10min./1cycle, period for 60min. each along X, Y, Z axes   |         |                |         |         |         |
| SAFETY & EMC                     | SAFETY STANDARDS  | UL8750, CSA C22.2 No.250.13-12, ENEC EN61347-1, EN61347-2-13, EN62384 independent, GB19510.14, GB19510.1 approved |         |                |         |         |         |
|                                  | DALI STANDARDS  | Comply with IEC62386-101, 102, 207  |         |                |         |         |         |
|                                  | WITHSTAND VOLTAGE   | I/P-O/P: 3.75KVAC   |         |                |         |         |         |
|                                  | ISOLATION RESISTANCE  | I/P-O/P: >100M Ohms / 500VDC / 25°C / 70% RH  |         |                |         |         |         |
|                                  | EMC EMISSION <small>Note.7</small>  | Compliance to EN55015, EN61000-3-2 Class C (@load ≥ 40%); EN61000-3-3; GB17625.1, GB17743                         |         |                |         |         |         |
|                                  | EMC IMMUNITY  | Compliance to EN61000-4-2, 3, 4, 5, 6, 8, 11, EN61547, light industry level (surge immunity Line-Line 2KV)        |         |                |         |         |         |
| OTHERS                           | MTBF  | 193.6K hrs min. MIL-HDBK-217F (25°C)  |         |                |         |         |         |
|                                  | DIMENSION   | 123.5*81.5*23mm (L*W*H)   |         |                |         |         |         |
|                                  | PACKING   | 0.24Kg; 54pcs/15Kg/1.12CUFT   |         |                |         |         |         |
| NOTE                             | <ol style="list-style-type: none"> <li>All parameters NOT specially mentioned are measured at 230VAC input, rated current and 25°C of ambient temperature.</li> <li>De-rating may be needed under low input voltages. Please refer to "STATIC CHARACTERISTIC" sections for details.</li> <li>Length of set up time is measured at first cold start. Turning ON/OFF the driver may lead to increase of the set up time.</li> <li>Efficiency is measured at 900mA/67V output set by DIP switch.</li> <li>Current ripple is measured 60%~100% of maximum voltage under rated power delivery.</li> <li>Standby power consumption is measured at 180~230VAC.</li> <li>The driver is considered as a component that will be operated in combination with final equipment. Since EMC performance will be affected by the complete installation, the final equipment manufacturers must re-qualify EMC Directive on the complete installation again.</li> </ol> |   |         |                |         |         |         |

**■ BLOCK DIAGRAM**

PFC fosc : 60KHz  
PWM fosc : 80KHz

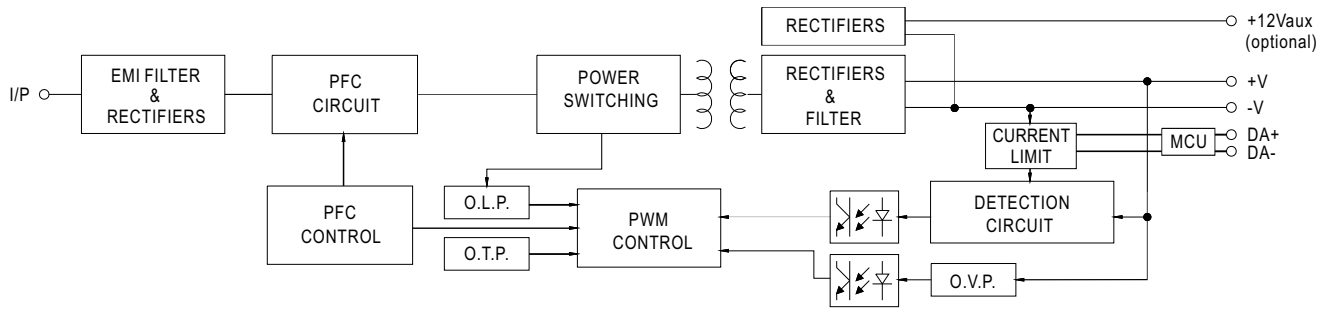

**■ DIP SWITCH TABLE**

LCM-60DA is a multiple-stage constant current driver, selection of output current through DIP switch is exhibited below.

| Io \ DIP S.W.          | 1    | 2    | 3    | 4    | 5    | 6    |
|------------------------|------|------|------|------|------|------|
| 500mA                  | ---- | ---- | ---- | ---- | ---- | ---- |
| 600mA                  | ON   | ---- | ---- | ---- | ---- | ---- |
| 700mA(factory default) | ON   | ON   | ---- | ---- | ---- | ---- |
| 900mA                  | ON   | ON   | ON   | ---- | ---- | ON   |
| 1050mA                 | ON   | ON   | ON   | ON   | ---- | ON   |
| 1400mA                 | ON   | ON   | ON   | ON   | ON   | ON   |

■ **DIMMING OPERATION**

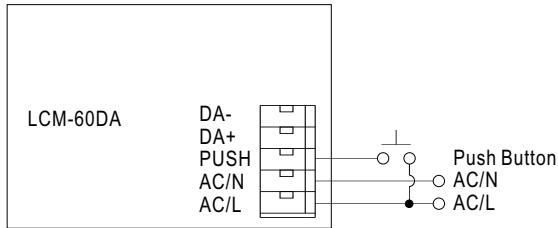

※ **PUSH dimming(primary side)**

| Action     | Action duration | Function  |
|------------|-----------------|---|
| Short push | 0.1~1 sec.      | Turn ON-OFF the driver  |
| Long push  | 1.5~10 sec.     | Every Long Push changes the dimming direction, dimming up or down |
| Reset      | >11 sec.        | Set up the dimming level to 100%                                  |

- The factory default dimming level is at 100%.
- If the push action lasts less than 0.05 sec., it will not lead to a change for the status of the driver.
- Up to 10 drivers can perform the PUSH dimming at the same time when utilizing one common push button.
- The maximum length of the cable from the push button to the last driver is 20 meters.
- The additive push button can be connected only between the PUSH terminal, as displayed in the diagram, and AC/L (in brown or black); it will lead to short circuit if it is connected to AC/N.

※ **DALI interface(primary side)**

- Apply DALI signal between DA+ and DA-
- DALI protocol comprises 16 groups and 64 addresses.
- First step is fixed at 6% of output.

**■ SYNCHRONIZATION OPERATION**

- Synchronization up to 10 drivers (1 master + 9 slaves)
- Maximum cable length between each unit : 20 meter.

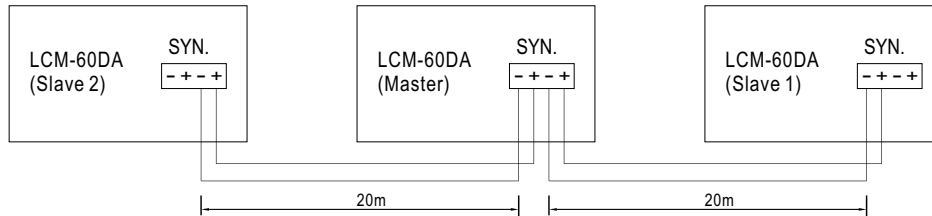

NOTE: Please make sure all units are set to 100% dimming setting(factory default) before synchronizing.

**■ TEMPERATURE COMPENSATION OPERATION**

LCM-60DA have the built-in temperature compensation function ; by connecting a temperature sensor (NTC resistor) between the +NTC / -NTC terminal of LCM-60DA and the detecting point on the lighting system or the surrounding environment, output current of LCM-60DA could be correspondingly changed, based on the sensed temperature, to ensure the long life of LED.

**NTC derating curve**

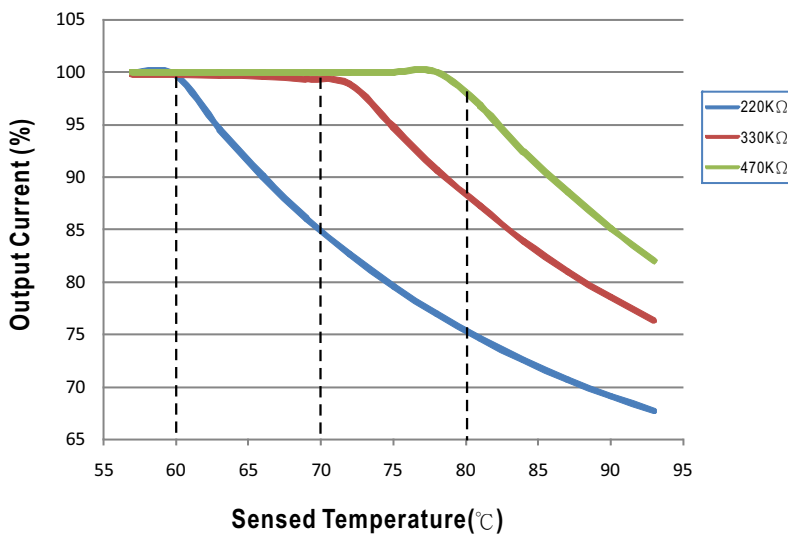

- ⊙ LCM-60DA can still be operated normally when the NTC resistor is not connected and the value of output current will be the current level selected through the DIP switch.
- ⊙ NTC reference:

| NTC resistance | Output Current  |
|----------------|---|
| 220K           | < 60°C, 100% of the rated current (corresponds to the setting current level)<br>> 60°C, output current begins to reduce, please refer to the curve for details. |
| 330K           | < 70°C, 100% of the rated current (corresponds to the setting current level)<br>> 70°C, output current begins to reduce, please refer to the curve for details. |
| 470K           | < 80°C, 100% of the rated current (corresponds to the setting current level)<br>> 80°C, output current begins to reduce, please refer to the curve for details. |

Notes: 1. MEAN WELL does not offer the NTC resistor and all the data above are measured by using THINKING TTC03 series.  
2. If other brands of NTC resistor is applied, please check the temperature curve first.

- ⊙ Dimming and synchronization function of the driver will be invalid when the "temperature compensation" function is in use.

■ **OUTPUT LOAD vs TEMPERATURE**

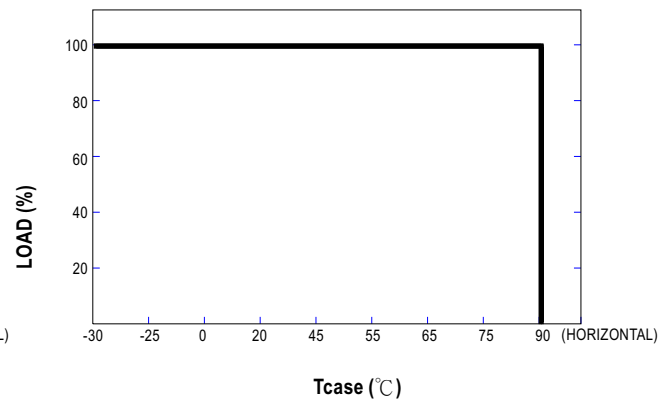
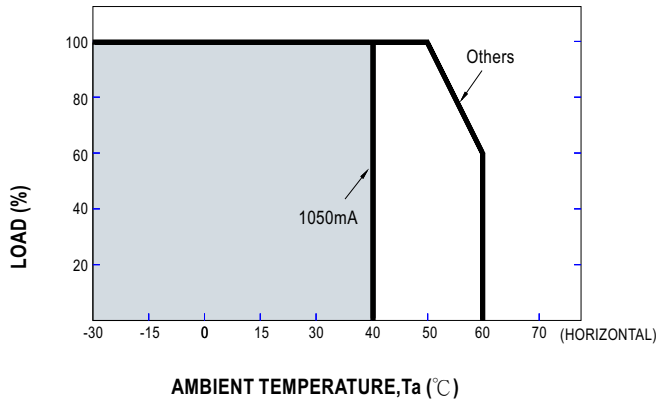

■ **STATIC CHARACTERISTIC**

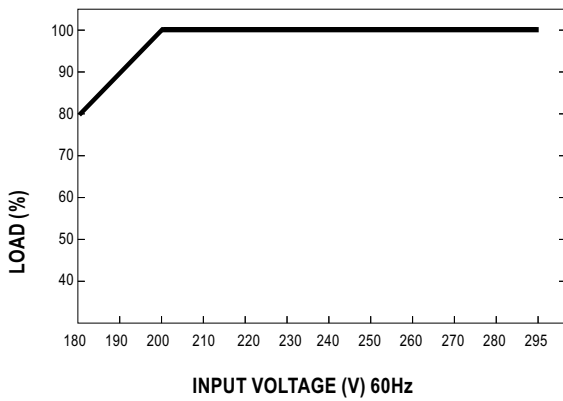

※ De-rating is needed under low input voltage.

**TOTAL HARMONIC DISTORTION (THD)**

※ Tcase at 80°C

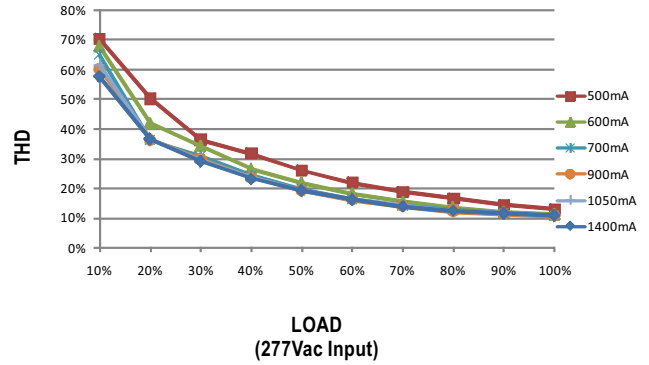
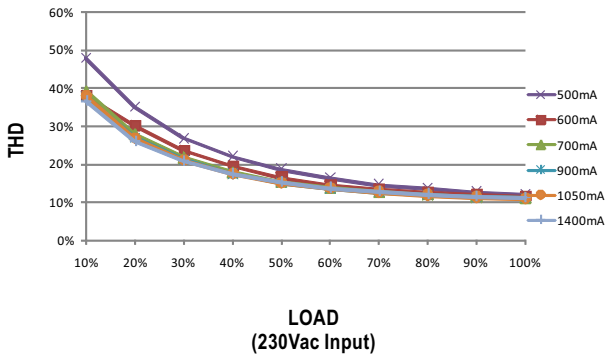

**POWER FACTOR (PF) CHARACTERISTIC**

※ Tcase at 80°C

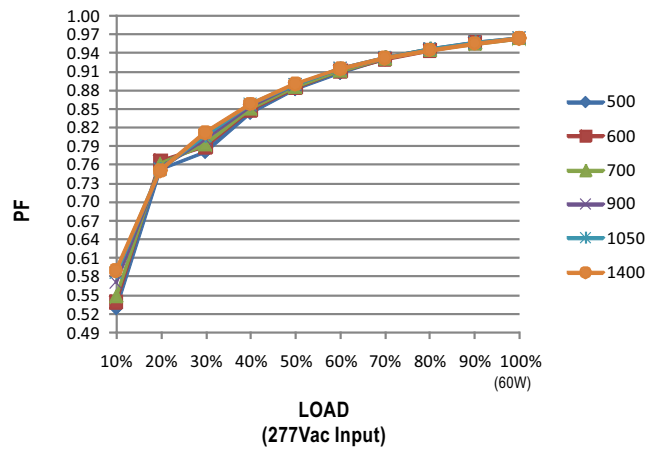
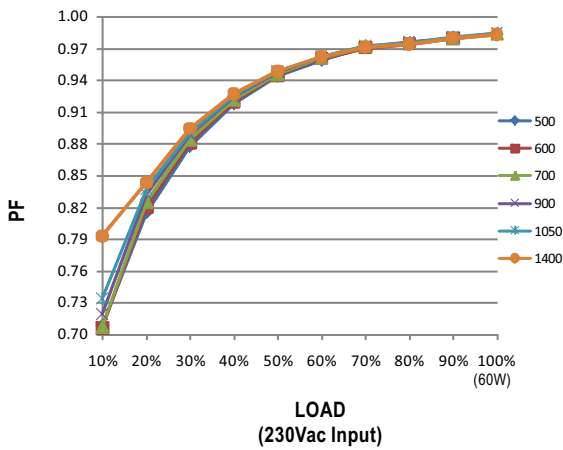

**EFFICIENCY vs LOAD**

LCM-60DA series possess superior working efficiency that up to 91% can be reached in field applications.

※ Tcase at 80°C

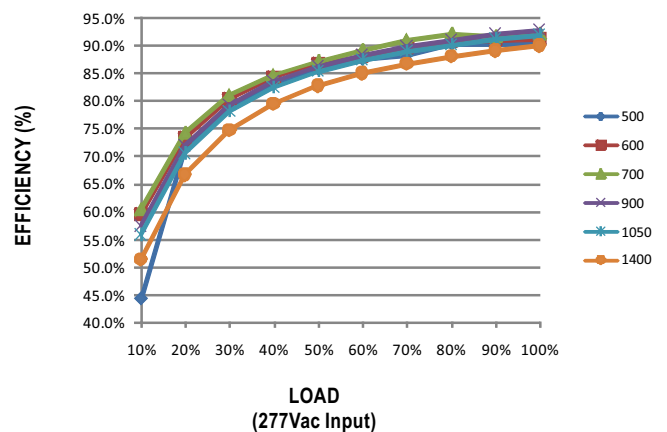
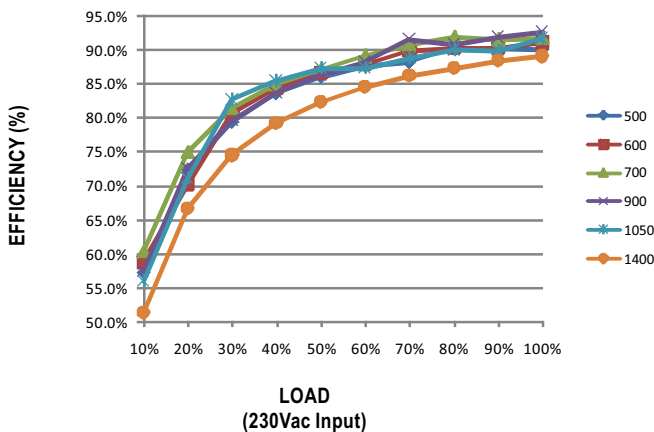

**MECHANICAL SPECIFICATION**

Case No.LCM-60A Unit:mm

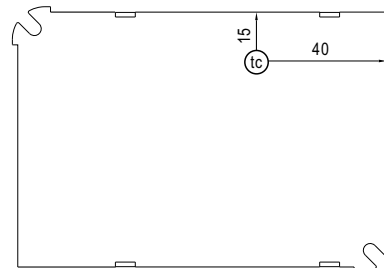
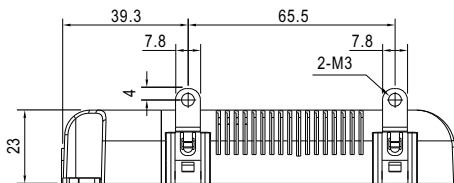
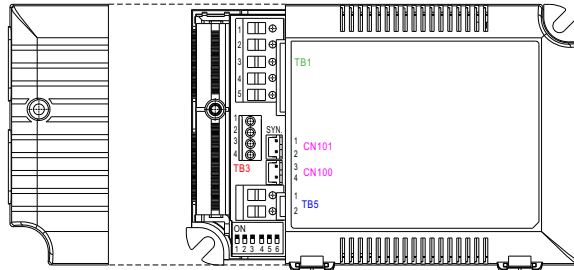
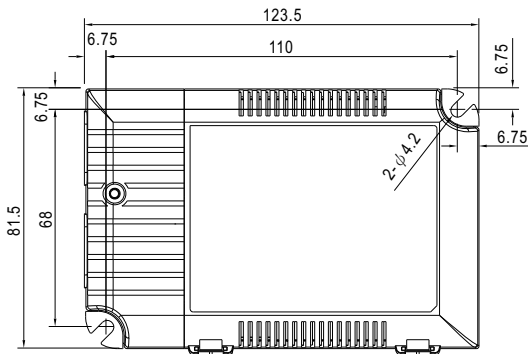

Bottom View

• (tc) : Max. Case Temperature

※ Terminal Pin No. Assignment(TB1)

| Pin No. | Assignment | Pin No. | Assignment |
|---------|------------|---------|------------|
| 1       | AC/L       | 4       | DA+        |
| 2       | AC/N       | 5       | DA-        |
| 3       | PUSH       |         |            |

※ Terminal Pin No. Assignment(TB3)

| Pin No. | Assignment     | Pin No. | Assignment |
|---------|----------------|---------|------------|
| 1       | +FAN(optional) | 3       | +NTC       |
| 2       | -FAN(optional) | 4       | -NTC       |

◎ Pin1(+FAN) / Pin2(-FAN) is the Auxiliary DC output for the optional model LCM-60DA-AUX; it can be used to drive fan.

※ Terminal Pin No. Assignment(TB5)

| Pin No. | Assignment |
|---------|------------|
| 1       | +V         |
| 2       | -V         |

※ SYN. Connector(CN101/CN100):JST B2B-XH or equivalent

| Pin No. | Assignment | Mating Housing           | Terminal                           |
|---------|------------|--------------------------|------------------------------------|
| 1,3     | +          | JST XHP<br>or equivalent | JST SXH-001T-P0.6<br>or equivalent |
| 2,4     | -          |                          |                                    |

**Installation Manual**

Please refer to : <http://www.meanwell.com/webapp/product/search.aspx?prod=lcm-60da>