



### ■ Features

- Universal AC input / Full range (up to 264VAC)
- High efficiency up to 91%
- Protections: Short circuit / Over current / Over voltage / Over temperature
- Class II power unit, no FG
- Class 2 power unit
- Fully isolated plastic case
- Fanless design, cooling by free air convection
- No load power consumption <0.15W
- Comply with EISA 2007 DoE and NRCAN
- UL LISTED, suitable for dry and damp locations
- 5 years warranty

### ■ Applications

- Indoor LED lighting
- LED decorative lighting
- LED office lighting
- General electronic products in dusty or humid environment

### ■ Description

OWA-60U is one 60W single-output external LED power supply series. Pairing the North American type of AC plug and the prevailing DC connectors, OWA-60U, working like an adaptor, simplifies the connection with LED lighting fixtures without extra wiring efforts. The entire series is certified with the "UL LISTED" for dry and damp locations.

As a class II (no FG) design, the enclosure of OWA-60U is a 94V-0 flame retardant plastic case. The interior is fully potted with silicone that enhances the heat dissipation. With the working efficiency up to 91%, OWA-60U is cooled by free air convection; the working temperature ranges from -35°C to +70°C.

### ■ Model Encoding

**OWA - 60U - 12**

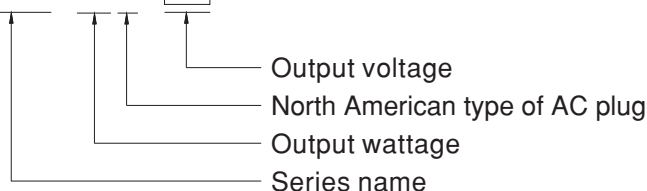



**SPECIFICATION**

MODEL		OWA-60U-12	OWA-60U-15	OWA-60U-20	OWA-60U-24	OWA-60U-30	OWA-60U-36	OWA-60U-42	OWA-60U-48	OWA-60U-54	
OUTPUT	DC VOLTAGE	12V	15V	20V	24V	30V	36V	42V	48V	54V	
	CONSTANT CURRENT REGION	6 ~ 12V	7.5 ~ 15V	10 ~ 20V	12 ~ 24V	15 ~ 30V	18 ~ 36V	21 ~ 42V	24 ~ 48V	27 ~ 54V	
	RATED CURRENT	5A	4A	3A	2.5A	2A	1.67A	1.5A	1.25A	1.12A	
	RATED POWER	60W	60W	60W	60W	60W	60.12W	63W	60W	60.48W	
	RIPPLE & NOISE (max.) Note.2	150mVp-p	150mVp-p	150mVp-p	150mVp-p	200mVp-p	200mVp-p	250mVp-p	250mVp-p	350mVp-p	
	VOLTAGE TOLERANCE Note.3	±4.0%	±4.0%	±4.0%	±3.0%	±3.0%	±2.0%	±1.0%	±1.0%	±1.0%	
	LINE REGULATION	±1.0%	±1.0%	±1.0%	±1.0%	±1.0%	±1.0%	±1.0%	±1.0%	±1.0%	
	LOAD REGULATION	±1.5%	±1.0%	±1.0%	±1.0%	±1.0%	±1.0%	±1.0%	±1.0%	±1.0%	
	SETUP, RISE TIME Note.4	500ms, 80ms/230VAC    1000ms, 80ms/115VAC at 95% load									
	HOLD UP TIME (Typ.)	10ms at full load    115VAC / 230VAC									
INPUT	VOLTAGE RANGE	90 ~ 264VAC		127 ~ 370VDC							
	FREQUENCY RANGE	47 ~ 63Hz									
	EFFICIENCY (Typ.)	115VAC	87%	88%	88%	88.5%	88.5%	88.5%	88.5%	88.5%	89%
		230VAC	88%	89%	89%	90%	90%	90%	90%	91%	91%
	AC CURRENT (Typ.)	1.2A / 115VAC		0.7A / 230VAC							
	INRUSH CURRENT (Typ.)	COLD START 35A(twidth=750μs measured at 50% Ipeak) at 115VAC COLD START 65A(twidth=750μs measured at 50% Ipeak) at 230VAC									
	MAX. No. of PSUs on 16A CIRCUIT BREAKER	2 units (circuit breaker of type B) / 4 units (circuit breaker of type C) at 230VAC									
LEAKAGE CURRENT	<0.25mA / 240VAC										
PROTECTION	OVER CURRENT	95 ~ 108% Protection type : Constant current limiting, recovers automatically after fault condition is removed									
	SHORT CIRCUIT	Hiccup mode, recovers automatically after fault condition is removed									
	OVER VOLTAGE	14 ~ 16V	17.5 ~ 23V	23 ~ 27V	28 ~ 34V	34 ~ 40V	41 ~ 50V	46 ~ 54V	53 ~ 62V	58 ~ 66V	
		Protection type : Shut down o/p voltage, re-power on to recover									
	OVER TEMPERATURE	Shut down o/p voltage, re-power on to recover									
ENVIRONMENT	WORKING TEMP.	-35 ~ +70°C (Refer to "Derating Curve")									
	WORKING HUMIDITY	20 ~ 95% RH non-condensing									
	STORAGE TEMP., HUMIDITY	-40 ~ +80°C, 10 ~ 95% RH									
	TEMP. COEFFICIENT	±0.03%/°C (0 ~ 50°C)									
	VIBRATION	10 ~ 500Hz, 5G 12min./1cycle, period for 72min. each along X, Y, Z axes									
SAFETY & EMC	SAFETY STANDARDS	UL8750 listed; CSA C22.2 No.250.13-12(except for 42V,48V,54V); IP67 approved for power body									
	WITHSTAND VOLTAGE	I/P-O/P:3.75KVAC									
	ISOLATION RESISTANCE	I/P-O/P:100M Ohms / 500VDC / 25°C / 70% RH									
	EMC EMISSION	Compliance to FCC Part15									
OTHERS	MTBF	292.8K hrs min.    MIL-HDBK-217F (25°C)									
	DIMENSION	130*53*35mm									
	PACKING	0.41Kg; 16pcs/6.8Kg/0.85CUFT									
NOTE	<p>1. All parameters NOT specially mentioned are measured at 230VAC input, rated load and 25°C of ambient temperature.</p> <p>2. Ripple &amp; noise are measured at 20MHz of bandwidth by using a 12" twisted pair-wire terminated with a 0.1uf &amp; 47uf parallel capacitor.</p> <p>3. Tolerance : includes set up tolerance, line regulation and load regulation.</p> <p>4. Length of set up time is measured at cold first start. Turning ON/OFF the power supply may lead to increase of the set up time.</p>										

■ Block Diagram

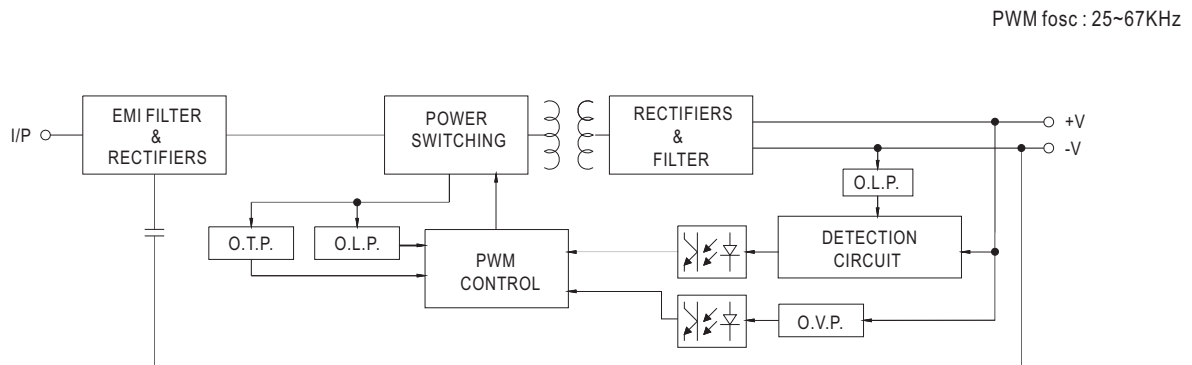

■ Derating Curve

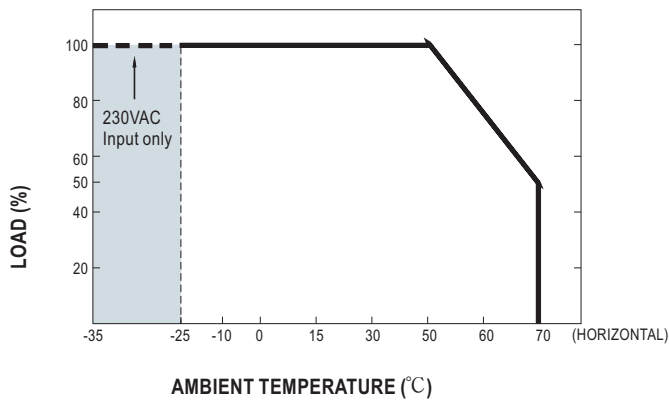

■ Static Characteristics

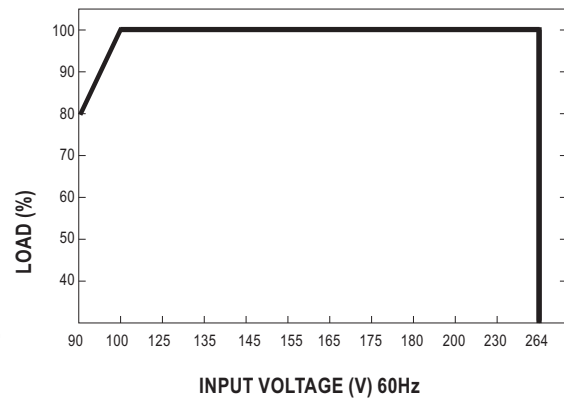

**EFFICIENCY vs LOAD (48V Model)**

OWA-60U series possess superior working efficiency that up to 91% can be reached in field applications.

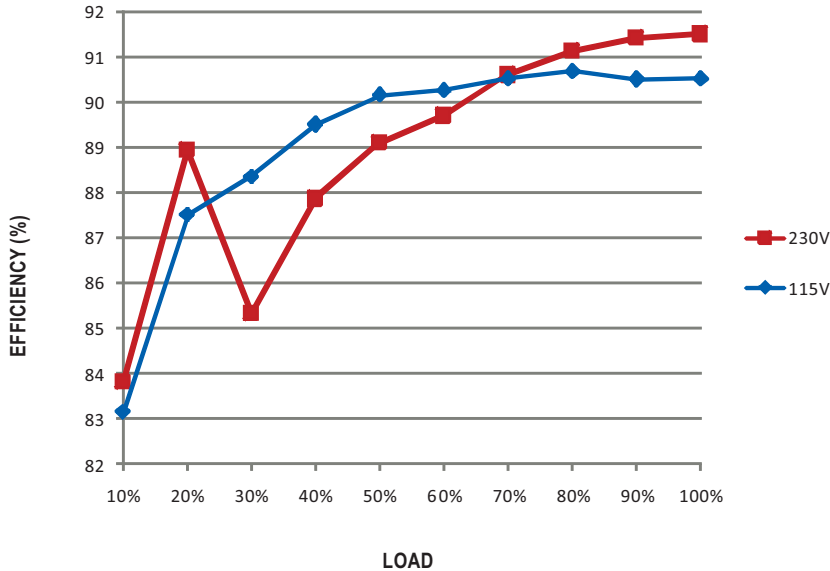

**DRIVING METHODS OF LED MODULE**

There are two major kinds of LED drive method, "direct drive" and "with LED driver".

A typical LED power supply may either work in "constant voltage mode (CV)" or "constant current mode (CC)" to drive the LEDs.

Mean Well's LED power supply with CV+ CC characteristic can be operated at both CV mode (with LED driver, at area (A) and CC mode (direct drive, at area (B)).

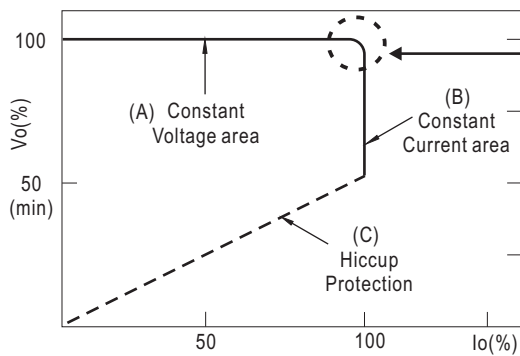

Typical LED power supply I-V curve

In the constant current region, the highest voltage at the output of the driver depends on the configuration of the end systems.

Should there be any compatibility issues, please contact MEAN WELL.

■ Mechanical Specification

CASE NO.: OWA-60 Unit:mm

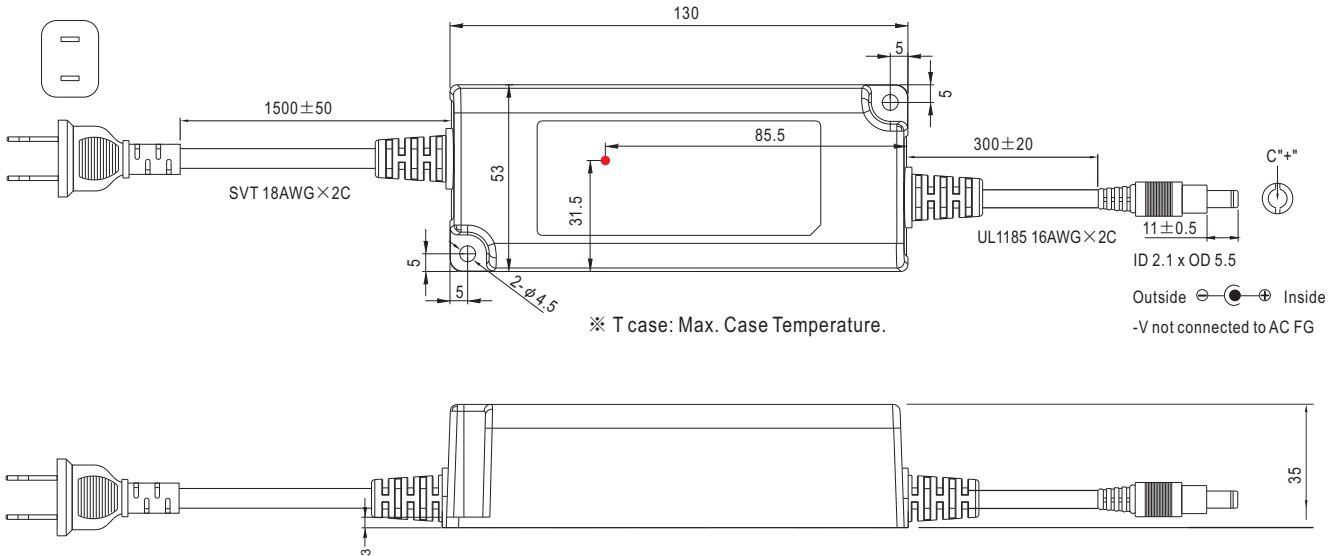

■ Input Plug Type

All models : NEMA 1-15p male plug

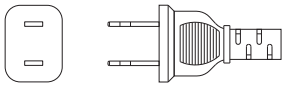

■ Output Plug Assignment

All models : 2.1φ x 5.5φ x 11 mm, center +, tuning fork type

	PIN NO.	OUTPUT
 Outside ⊖ ⊕ Inside	CENTER	+V

■ Recommend Mounting Direction

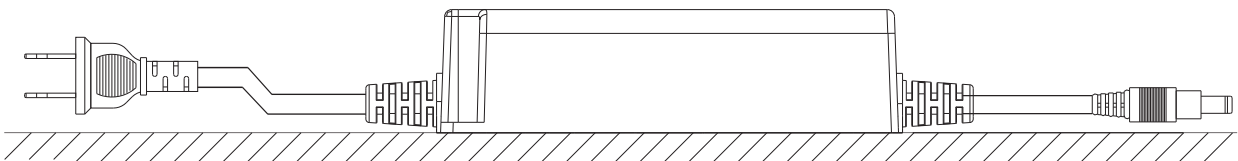

■ Installation Manual

Please refer to : <http://www.meanwell.com/webnet/search/InstallationSearch.html>