



85W Dual Output Switching Power Supply

RD-85 series



■ Features :

- Universal AC input / Full range
- Protections: Short circuit / Overload / Over voltage
- Cooling by free air convection
- LED indicator for power on
- 100% full load burn-in test
- All using 105°C long life electrolytic capacitors
- Withstand 300VAC surge input for 5 second
- High operating temperature up to 70°C
- Withstand 5G vibration test
- High efficiency, long life and high reliability
- 3 years warranty



SPECIFICATION

MODEL	RD-85A		RD-85B		
OUTPUT	OUTPUT NUMBER	CH1	CH2	CH1	CH2
	DC VOLTAGE	5V	12V	5V	24V
	RATED CURRENT	8A	4A	8A	2A
	CURRENT RANGE <small>Note.6</small>	2 ~ 10A	0.3 ~ 5A	2 ~ 10A	0.3 ~ 2.5A
	RATED POWER <small>Note.6</small>	88W		88W	
	RIPPLE & NOISE (max.) <small>Note.2</small>	80mVp-p	120mVp-p	80mVp-p	120mVp-p
	VOLTAGE ADJ. RANGE	CH1: 4.75 ~ 5.5V		CH1: 4.75 ~ 5.5V	
	VOLTAGE TOLERANCE <small>Note.3</small>	±2.0%	±5.0%	±2.0%	±5.0%
	LINE REGULATION <small>Note.4</small>	±0.5%	±1.0%	±0.5%	±1.0%
	LOAD REGULATION <small>Note.5</small>	±1.0%	±3.0%	±1.0%	±3.0%
SETUP, RISE TIME	500ms, 20ms/230VAC 1200ms, 30ms/115VAC at full load				
HOLD UP TIME (Typ.)	100ms/230VAC 18ms/115VAC at full load				
INPUT	VOLTAGE RANGE	88 ~ 264VAC 125 ~ 373VDC (Withstand 300VAC surge for 5sec. Without damage)			
	FREQUENCY RANGE	47 ~ 63Hz			
	EFFICIENCY(Typ.)	78%		80%	
	AC CURRENT (Typ.)	2.5A/115VAC 1.5A/230VAC			
	INRUSH CURRENT (Typ.)	COLD START 40A/230VAC			
LEAKAGE CURRENT	<2mA / 240VAC				
PROTECTION	OVERLOAD	110 ~ 150% rated output power Protection type : Hiccup mode, recovers automatically after fault condition is removed			
	OVER VOLTAGE	CH1: 5.75 ~ 6.75V Protection type : Hiccup mode, recovers automatically after fault condition is removed			
ENVIRONMENT	WORKING TEMP.	-25 ~ +70°C (Refer to "Derating Curve")			
	WORKING HUMIDITY	20 ~ 90% RH non-condensing			
	STORAGE TEMP., HUMIDITY	-40 ~ +85°C, 10 ~ 95% RH			
	TEMP. COEFFICIENT	±0.03%/°C (0 ~ 50°C) on +5V output			
VIBRATION	10 ~ 500Hz, 5G 10min./1cycle, period for 60min. each along X, Y, Z axes				
SAFETY & EMC (Note 7)	SAFETY STANDARDS	UL60950-1, TUV EN60950-1 approved			
	WITHSTAND VOLTAGE	I/P-O/P:3KVAC I/P-FG:2KVAC O/P-FG:0.5KVAC			
	ISOLATION RESISTANCE	I/P-O/P, I/P-FG, O/P-FG:100M Ohms / 500VDC / 25°C / 70% RH			
	EMC EMISSION	Compliance to EN55022 (CISPR22) Class B, EN61000-3-2,-3			
EMC IMMUNITY	Compliance to EN61000-4-2,3,4,5,6,8,11, EN61000-6-2 (EN50082-2), heavy industry level, criteria A				
OTHERS	MTBF	239.4Khrs min. MIL-HDBK-217F (25°C)			
	DIMENSION	159*97*38mm (L*W*H)			
	PACKING	0.6Kg; 24pcs/15.4Kg/0.7CUFT			
NOTE	<ol style="list-style-type: none"> 1. All parameters NOT specially mentioned are measured at 230VAC input, rated load and 25°C of ambient temperature. 2. Ripple & noise are measured at 20MHz of bandwidth by using a 12" twisted pair-wire terminated with a 0.1uF & 47uF parallel capacitor. 3. Tolerance : includes set up tolerance, line regulation and load regulation. 4. Line regulation is measured from low line to high line at rated load. 5. Load regulation is measured from 20% to 100% rated load, and other output at 60% rated load. 6. Each output can work within current range. But total output power can't exceed rated output power. 7. The power supply is considered a component which will be installed into a final equipment. All the EMC tests are been executed by mounting the unit on a 360mm*360mm metal plate with 1mm of thickness. The final equipment must be re-confirmed that it still meets EMC directives. For guidance on how to perform these EMC tests, please refer to "EMI testing of component power supplies." (as available on http://www.meanwell.com) 8. Length of set up time is measured at cold first start. Turning ON/OFF the power supply very quickly may lead to increase of the set up time. 				

Mechanical Specification

Case No. 901C Unit:mm

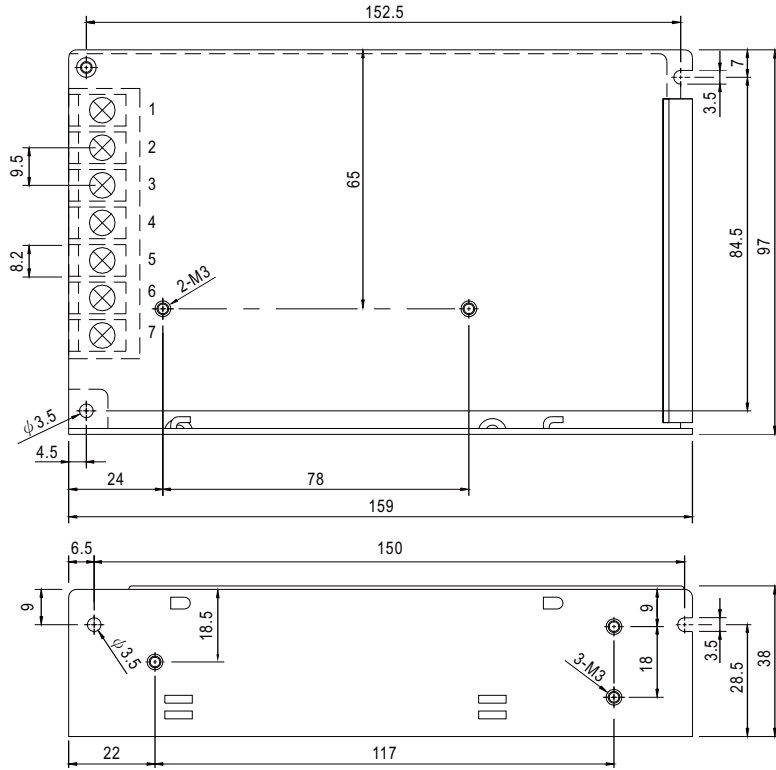

Terminal Pin No. Assignment

Pin No.	Assignment	Pin No.	Assignment
1	AC/L	4,6	DC OUTPUT COM
2	AC/N	5	DC OUTPUT +V2
3	FG \perp	7	DC OUTPUT +V1

Block Diagram

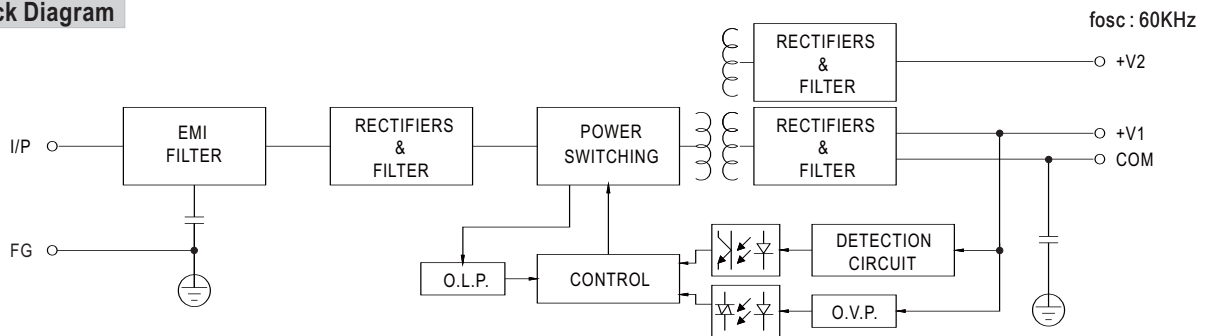

Derating Curve

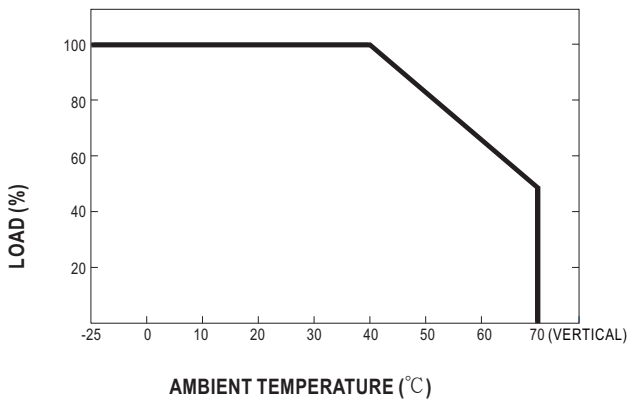

Static Characteristics

